

Data Sheet

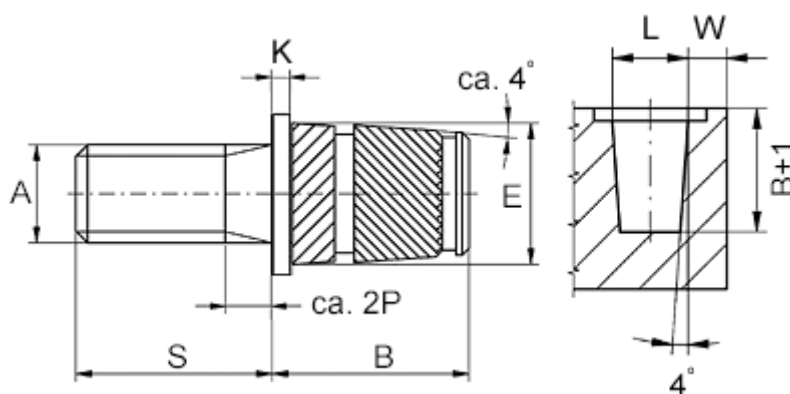

Article number: 12859100020860
Description: KLEE-coil 859 100 020.860
M2 Brass

Measures



Flange diameter E1	= 5.6
Flange height	= 0.6
Male thread A	= M2x0,4
Min distance to edge W	= 1.5
Mounting length B	= 5.6
Outer diameter E	= 4.1
Pin length S	= 16
Recommended bore diameter W +0.1	= 3.8